

Brochure | April 2012

Moulded-case circuit-breakers overview SACE Tmax

A single family of moulded-case circuit-breakers up to 3200 A

Tmax moulded-case circuit-breakers guarantee an extremely high performance level while being progressively smaller in size, simple to install and able to provide increasingly better safety guarantees for the operator.

In addition to being ideal for the secondary distribution of alternate and direct current, they feature dedicated solutions for all application requirements.

Moulded-case circuit-breakers can be used in low voltage civil and industrial installations with 1 to 3200 A operating current. The Tmax family includes 9 circuit-breaker sizes in three- or four-pole versions:

- XT1, XT2, XT3 and XT4 up to 250A;
- T4, T5 and T6 up to 1000A;
- T7 and T8 up to 3200A.

The ultimate short-circuit breaking capacity (I_{cu}) at 415V ranges from 18kA to 200kA, or up to 100kA for 690V.

The following ranges are available:

- Circuit-breakers for AC and DC power distribution;
- Circuit-breakers for zone selectivity;
- Circuit-breakers for motor protection;
- Circuit-breakers for up to 1150V AC and 1000V DC applications;
- Switch-disconnectors.

All Tmax circuit breakers can be enhanced with a vast range of standardized accessories. This convenience not only cuts down on inventory, but creates an extremely flexible and easily managed solution.

Tmax circuit-breakers can be equipped with thermomagnetic, solely magnetic or electronic trip units, all of which are interchangeable.

Since assembly instructions are simple, trip units can quickly and easily be replaced; even in the field.

All this makes the circuit-breakers very easy to operate with considerable savings due to rationalized stock management.

Up to 250 A

Up to 1000 A

Up to 3200 A

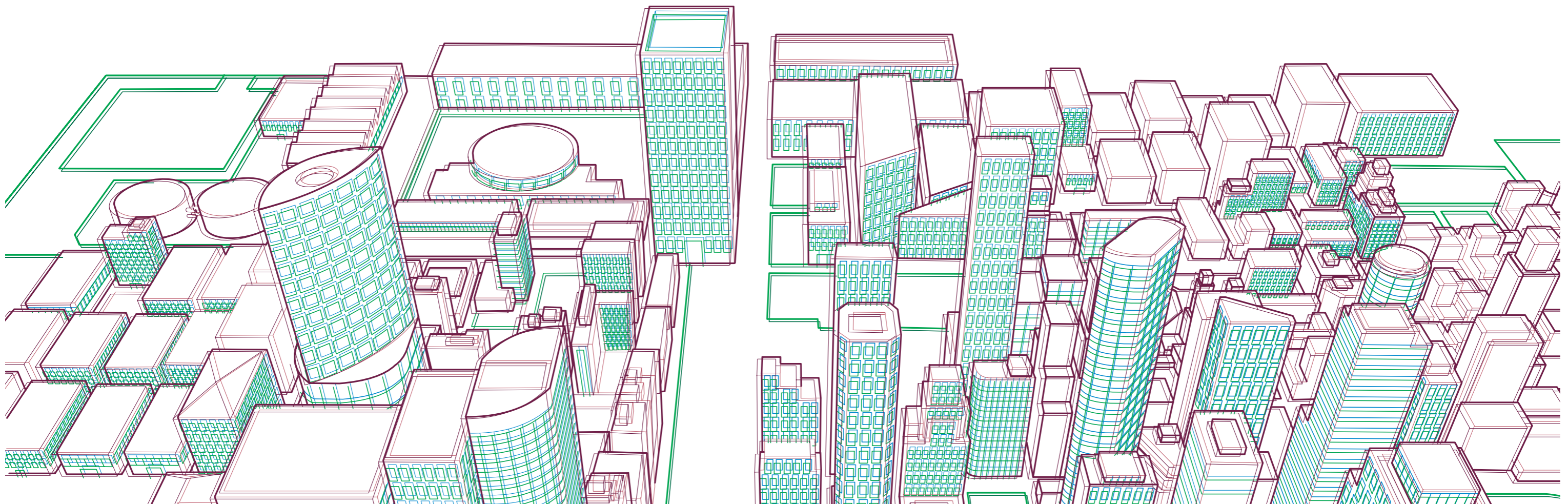

A single family of moulded-case circuit-breakers up to 3200 A

Construction characteristics

Up to 250 A

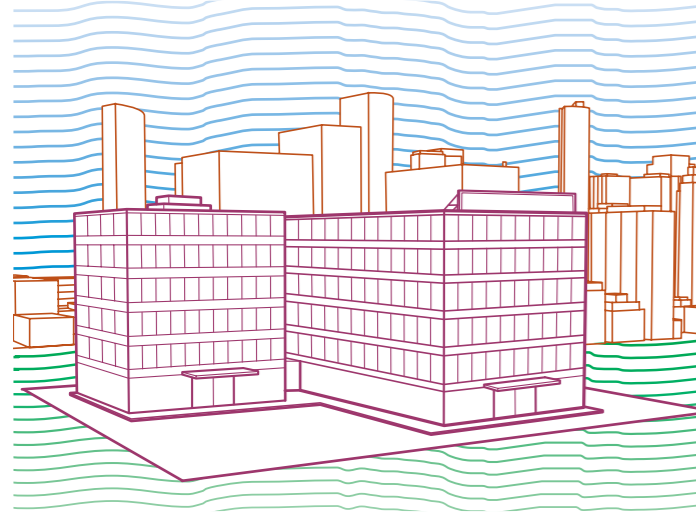

SACE Tmax		XT1					XT2					XT3		XT4				
Size	[A]	160					160					250		160/250				
Rated service voltage, Ue	(AC) 50-60Hz [V]	690					690					690		690				
	(DC) [V]	500					500					500		500 ⁽⁴⁾				
Versions		Fixed, Plug-in ⁽¹⁾					Fixed, Plug-in, Withdrawable					Fixed, Plug-in		Fixed, Plug-in, Withdrawable				
Breaking capacity according to IEC 60947-2																		
Rated ultimate short-circuit breaking capacity, Icu																		
Icu @ 220-230-240V 50-60Hz (AC)	[kA]	B	C	N	S	H	N	S	H	L	V	N	S	N	S	L	H	V
Icu @ 415V 50-60Hz (AC)	[kA]	25	40	65	85	100	65	85	100	150	200	50	85	65	85	100	150	200
Icu @ 690V 50-60Hz (AC)	[kA]	18	25	36	50	70	36	50	70	120	150	36	50	36	50	70	120	150
(DC) 500V - 2 poles in series	[kA]	3	4	6	8	10	10	12	15	18	20	5	6	10	12	15	20	25/100 ⁽²⁾
(DC) 500V - 3 poles in series	[kA]	-	-	-	-	-	-	-	-	-	-	-	-	36	50	70	85	100
(DC) 750V - 3 poles in series	[kA]	18 ⁽³⁾	25 ⁽³⁾	36 ⁽³⁾	50 ⁽³⁾	70 ⁽³⁾	36	50	70	85	100	36	50	36	50	70	85	100
Rated service short-circuit breaking capacity, Ics																		
Ics @ 220-230-240V 50-60Hz (AC)	[kA]	100%	100%	75%(50)	75%	75%	100%	100%	100%	100%	100%	75%	50%	100%	100%	100%	100%	100%
Ics @ 415V 50-60Hz (AC)	[kA]	100%	100%	100%	75%	50%(37.5)	100%	100%	100%	100%	100%	75%	50%(27)	100%	100%	100%	100%	100%
Ics @ 690V 50-60Hz (AC)	[kA]	100%	100%	100%	75%	50%	100%	100%	100%	75% (15); 75% (15)	100%	75%	50%	100%	100%	100%	100%	75% (20)
Mechanical life	[N° Operations]	25000					25000					25000		25000				
	[N° Hourly operations]	240					240					240		240				
Electrical life @ 415V (AC)	[N° Operations]	8000					8000					8000		8000				
	[N° Hourly operations]	120					120					120		120				
Dimensions	3 poles [mm]	76,2x70x130					90x82,5x130					105x70x150		105x82,5x160				
	4 poles [mm]	101,6x70x130					120x82,5x130					140x70x150		140x82,5x160				

Up to 1000 A

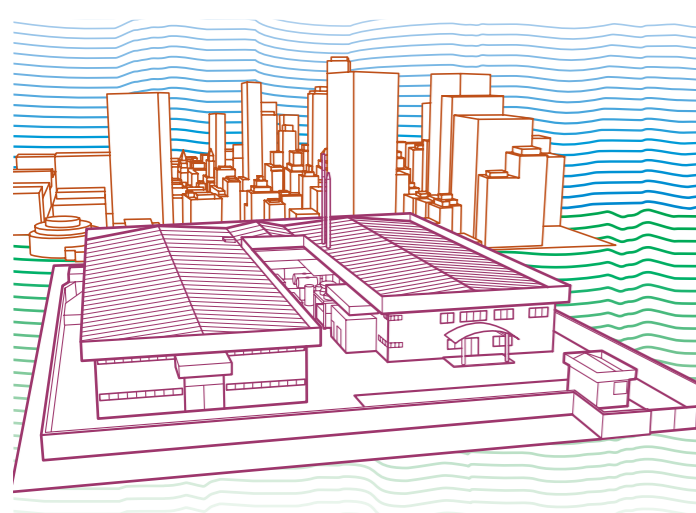

SACE Tmax		T4					T5					T6					
Size	[A]	320					400/630					630/800/1000					
Rated service voltage, Ue	(AC) 50-60Hz [V]	690					690					690					
	(DC) [V]	750					750					750					
Versions		Fixed, Plug-in, Withdrawable					Fixed, Plug-in, Withdrawable					Fixed, Withdrawable ⁽⁵⁾					
Breaking capacity according to IEC 60947-2																	
Rated ultimate short-circuit breaking capacity, Icu																	
Icu @ 220-230-240V 50-60Hz (AC)	[kA]	N	S	H	L	V	N	S	H	L	V	N	S	H	L	V ⁽⁶⁾	
Icu @ 415V 50-60Hz (AC)	[kA]	70	85	100	200	200	70	85	100	200	200	70	85	100	200	200	
Icu @ 690V 50-60Hz (AC)	[kA]	36	50	70	120	200	36	50	70	120	200	36	50	70	100	150	
(DC) 500V - 2 poles in series	[kA]	20	25	40	70	80	20	25	40	70	80	20	22	25	30	40	
(DC) 500V - 3 poles in series	[kA]	25	36	50	70	100	25	36	50	70	100	20	35	50	65	70	
(DC) 750V - 3 poles in series	[kA]	-	-	-	-	-	-	-	-	-	-	-	-	-	-	-	
Icu @ 750V - 3 poles in series	[kA]	16	25	36	50	70	16	25	36	50	70	16	20	36	50	50	
Rated service short-circuit breaking capacity, Ics																	
Ics @ 220-230-240V 50-60Hz (AC)	[kA]	100%	100%	100%	100%	100%	100%	100%	100%	100%	100%	100%	100%	100%	100%	75%	100%
Ics @ 415V 50-60Hz (AC)	[kA]	100%	100%	100%	100%	100%	100%	100%	100%	100%	100%	100%	100%	100%	100%	75%	75%
Ics @ 690V 50-60Hz (AC)	[kA]	100%	100%	100%	100%	100%	100%	100%	100%	100%	100%	100%	75%	75%	75%	75%	75%
Mechanical life	[N° Operations]	20000					20000					20000					
	[N° Hourly operations]	240					120					120					
Electrical life @ 415V (AC)	[N° Operations]	6000					7000 (400 A) - 5000 (630 A)					7000 (630A) - 5000 (800A) - 4000 (1000A)					
	[N° Hourly operations]	120					60					60					
Dimensions	3 poles [mm]	105 x 103.5 x 205					140 x 103.5 x 205					210 x 103.5 x 268					
	4 poles [mm]	140 x 103.5 x 205					186 x 103.5 x 205					280 x 103.5 x 268					

Up to 3200 A

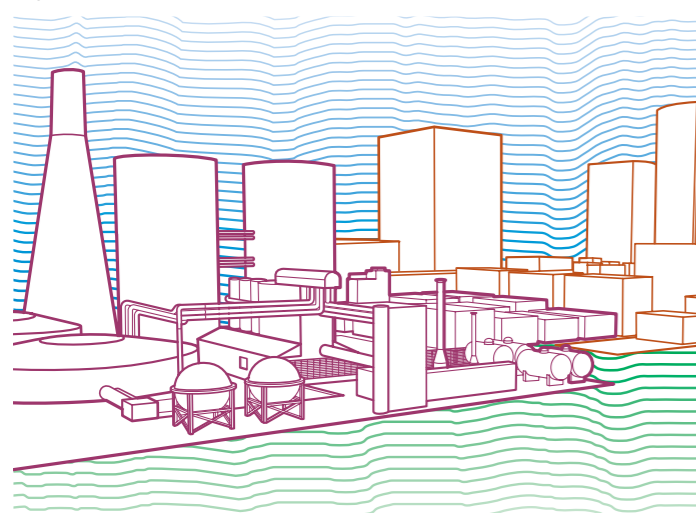

SACE Tmax		T7					T8	
Size	[A]	800/1000/1250/1600					2000/2500/3200	
Rated service voltage, Ue	(AC) 50-60Hz [V]	690					690	
	(DC) [V]	-					-	
Versions		Fixed, Withdrawable					Fixed	
Breaking capacity according to IEC 60947-2								
Rated ultimate short-circuit breaking capacity, Icu								
Icu @ 220-230-240V 50-60Hz (AC)	[kA]	S	H	L	V ⁽⁶⁾	X ⁽¹⁰⁾	L	V
Icu @ 415V 50-60Hz (AC)	[kA]	85	100	200	200	170	85	130
Icu @ 690V 50-60Hz (AC)	[kA]	50	70	120	150	170	85	130
(DC) 500V - 2 poles in series	[kA]	30	42	50	60	75	50	80
(DC) 500V - 3 poles in series	[kA]	-	-	-	-	-	-	-
(DC) 750V - 3 poles in series	[kA]	-	-	-	-	-	-	-
Rated service short-circuit breaking capacity, Ics								
Ics @ 220-230-240V 50-60Hz (AC)	[kA]	100%	100%	100%	100%	100%	100%	75%
Ics @ 415V 50-60Hz (AC)	[kA]	100%	100%	100%	100%	100%	100%	75%
Ics @ 690V 50-60Hz (AC)	[kA]	100%	75%	75%	75%	100%	100%	75%
Mechanical life	[N° Operations]	10000					15000	
	[N° Hourly operations]	60					60	
Electrical life @ 415V (AC)	[N° Operations]	2000 (versioni S, H, L) / 3000 (versione V)					4500(2000A);4000 (2500A);3000 (3200A)	
	[N° Hourly operations]	60					20	
Dimensions	3 poles [mm]	210 x 154 (leva) / 178 (motorizzabile) x 268					427 x 282 x 382	
	4 poles [mm]	280 x 154 (leva) / 178 (motorizzabile) x 268					553 x 282 x 382	

⁽¹⁾ XT1 plug-in In max=125A
⁽²⁾ 25kA@690V available for XT4 250; 100kA@690V available for XT4 160
⁽³⁾ XT1 500V DC 4 poles in series
⁽⁴⁾ XT4 750V DC ask ABB SACE whether available
⁽⁵⁾ Withdrawable not available for T6 1000A
⁽⁶⁾ V version only available for frame 630A/800A
⁽⁷⁾ 75% for T5 630
⁽⁸⁾ 50% for T5 630
⁽⁹⁾ Only for T7 800/1000/1250
⁽¹⁰⁾ Only for T7 800

A single family of moulded-case circuit-breakers up to 3200 A

Distribution solutions

1
XT4 250 TMA 3p
 Thermomagnetic trip unit TMA for AC/DC applications. Thermal protection is adjustable $I_1 = 0.7 \dots 1xI_n$, magnetic protection is adjustable $I_3 = 5 \dots 10xI_n$.



2
XT1 160 TMD 3p with RC Sel
 Thermomagnetic trip unit TMD for AC/DC applications. Thermal protection is adjustable $I_1 = 0.7 \dots 1xI_n$, magnetic protection is fixed $I_3 = 10xI_n$.



RC SEL is a selective residual current release for assembly in conjunction with the circuit-breaker. It has adjustable current thresholds and 2xI_n adjustable non-actuating times.



3
T5S 630 PR221DS LS/I 3p
 Electronic trip unit PR221DS LS/I for AC applications. Features a protection L function against overload with adjustable current, ($I_1 = 0.4 \dots 1xI_n$), and timing. Protection against short-circuit can be delayed (S), with an adjustable, or instantaneous delay (I). The tripping threshold is adjustable in both cases ($I_2, I_3 = 1 \dots 10xI_n$).



Tmax moulded-case circuit-breakers are the ideal solution for all distribution levels, from the main low voltage switchboard to the subswitchboards in the installation. They feature high peak current and specific let-through energy-limiting characteristics that allow the circuits and equipment on the load side to be sized in an optimum way.

The SACE Tmax family of moulded-case circuit-breakers is available with:

- thermomagnetic trip units for protecting direct and alternate current networks. These trip units use the physical properties of a bimetal and an electromagnet to detect the overloads and short-circuits;
- electronic trip units for protecting alternate current networks. These trip units use microprocessor technology to obtain protection functions that make the operations extremely reliable and accurate.

Due to dedicated devices, the SACE Tmax family of moulded-case circuit-breakers allows the insulation state of the installation to be monitored and ensures that people are protected against direct and indirect contacts, in accordance with the reference standards.

Selectivity and back-up

Selective coordination can be used among various protection devices in an installation when it is necessary to minimize the problems associated with faults and abnormal service conditions.

If selective coordination is not a requirement, back-up protection can be used. This method implies that the supply side device provides protection during a short-circuit, allowing the use of a lower breaking capacity device on the load side.

Selectivity

As can be seen from the selectivity tables, there is total selectivity (T), equal to 50 A, between a Tmax XT4S TM and T5S EL.

Advantages:

- Continuity of service
- Rapid identification of the fault zone

Load side	Version	Relay	Model	Sup. side		
				T5		
				400	400	630
XT4	S	TM	200	⊖	⊖	⊖
			225	⊖	⊖	⊖
			250	⊖	⊖	⊖

Back-up

As can be seen from the back-up tables, the back-up value between a Tmax XT1C and a T5S is 50 kA.

Advantages:

- Financial savings

Load side	Version	I_{cu} [kA]	Supply side						
			XT1	XT2	XT3	XT4	T5	T6	T7
XT1	C	25	S						
						50	50	50	40

Circuit-breakers for distribution

Trip unit	Frame [A]									
	160	250	400	500	630	800	1000	1600	2500	3200
TMD (Adjustable Thermal, Fixed Magnetic)	Tmax XT1-XT3									
TMA (Adjustable Thermal, Adjustable Magnetic)	Tmax XT2-XT4-T5-T6									
LS/I (Electronic trip unit)	Tmax XT2-XT4-T4-T5-T6-T7-T8									
Residual Current Devices		Frame [A]								
RC Instantaneous	Tmax XT1-XT3									
RC Selective	Tmax XT2-XT4-T4-T5									
Integrated RC Protection in release									Tmax T7-T8	
RC on outside of switchboard (RCQ)	Tmax XT1-XT3-XT4-T4-T5-T6-T7									

A single family of moulded-case circuit-breakers up to 3200 A

Solutions for energy measurement and communication

1
XT4 250 Ekip E-LSIG 3p - Ekip Com, MOE-E
 Due to its integrated current and voltage sensors, the Ekip E electronic trip unit can measure both the main electrical quantities and the most advanced Power quality indicators; such as Power Factor, Harmonic distortion and THD.
 By means of the trip unit and Ekip Com Communication module, the MOE-E motor operator allows the digital signals from the supervision and control system to be used and converted into power signals for operating the circuit-breaker in the remote mode.



2
T5 400 PR223DS 3p - MOE-E, VM210
 Due to the conventional L, S, I and G protection functions, the PR223DS trip unit also allows the main electrical quantities to be measured.
 Using the VM210 accessory and without the need for voltage transformers, the user can obtain both the current values and the voltage, power and energy values in the local and remote modes via a supervising and control system.



3
T7M 1600 PR332/P 3p - PR330/V, PR330/D-M
 The SACE PR332 trip unit for Tmax T7 provides a sophisticated and flexible protection system. Fitted with the PR330/D-M internal dialogue module, PR332/P becomes a smart protection, measuring and communication device based on the Modbus® RTU protocol. Module PR330/V measures and processes the neutral and phase voltages, then transfers these data to the protection release so that a set of protection and measuring functions can be implemented.



4
HMI030
 This device, which can be installed on the front of the switchboard, comprises a graphic display showing all the measurements and alarms/events of the trip unit. Thanks to its high-level accuracy, the device is a valid substitute for conventional multimeters without the need for current/voltage transformers.



5
XT2 160 Ekip LSIG 3p - Ekip Com, Ekip Display
 Ekip Display is a unit that can be applied to the front of the advanced electronic trip unit and shows the current values, voltage values, alarms and programmed protection and communication parameter settings.



A low voltage electrical installation is similar to an industrial process for electricity distribution and needs a supervisory and monitoring system that is able to increase reliability and optimize management.

To achieve integration between conventional plant engineering techniques and control systems for the purpose of running, controlling and monitoring civil and industrial installations in a centralized and automatic way, one can consider the electrical installation as being affected by two flows:

- a main flow (energy flow) formed by the power and energy supplied to the users and loads of an installation through the line conductors and control and protection devices;
- an information flow (digital flow) formed by all the information, data and commands required to control and manage the installation.

The supervisory system handles the flow of information that transits through the communication network.

Circuit-breakers for energy measurement and communication

Trip units	Frame [A]									
	160	250	400	500	630	800	1000	1600	2500	3200
LSI (Advanced electronic trip unit)	Tmax XT2-XT4-T4-T5-T6-T7-T8									
LSIG (Advanced electronic trip unite)	Tmax XT2-XT4-T4-T5-T6-T7-T8									
Functions	Frame [A]									
	160	250	400	500	630	800	1000	1600	2500	3200
Energy measurement	Tmax XT4-T4-T5-T6-T7-T8									
Supervision and Monitoring	Tmax XT4-T4-T5-T6-T7-T8									

In this type of installation, the circuit-breaker acts as both sensor and actuator. As a sensor, it collects sensitive information and data and sends them to the supervision system. As an actuator, it executes the command received from the control device (e.g. PC or PLC). These characteristics are of particular importance since they meet the growing demands for circuit-breaker integration into latest generation networks (Smart Grid).

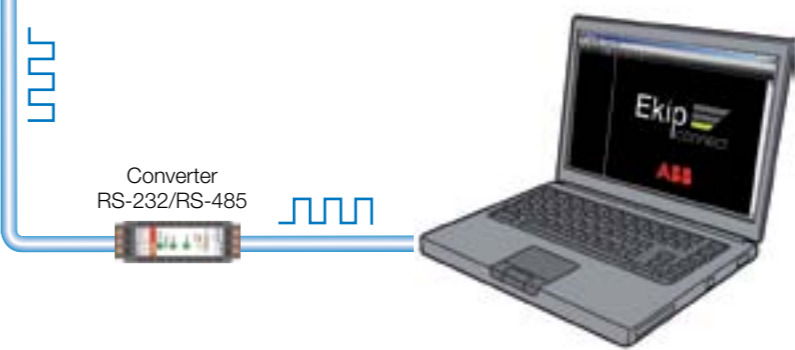

A single family of moulded-case circuit-breakers up to 3200 A

Automatic network-generator transfer solutions

1

ATS022

The ATS022 device monitors both the supply lines and analyzes phase, frequency imbalance and phase loss. In addition to the standard control functions, ATS022 allows you to: select the priority line, control a third circuit-breaker, integrate the device into a supervision system with Modbus communication, read and enter the parameters, display measurements and alarms using a graphic display.



2

T7 M (CB1) and T7 M (CB2) Interlocked XT4 (CB3) for disconnection

Non-priority loads (NPL)

To achieve a correct configuration, each circuit-breaker connected to the ATS must be accessorized with:

- mechanical interlock;
- motor operator for opening and closing;
- key lock against sole manual operation for MOE motor operators;
- state (open/closed) and tripped contact signalling contact;
- connected contact (for the withdrawable circuit-breaker version).

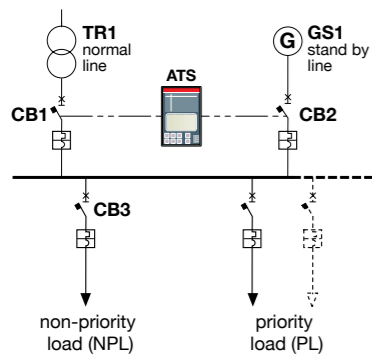

The ATS (Automatic Transfer Switch) is the network-generator transfer unit used in installations where switching the main power line to an emergency one is required in order to ensure power supply to the loads in the case of anomalies in the main line.

The new generation of ATS (ATS021 and ATS022) offers the most advanced and complete solutions to guarantee service continuity. The ATS021 and ATS022 can be used both with all the circuitbreakers in the SACE Tmax XT family and with the switch-disconnectors. Reliable, safe and smart, the new ATS family conforms to international standards, is easy to configure and is suitable for all applications.

Fully coordinated systems are ensured, since ATS integrates perfectly with the entire range of ABB circuit-breakers and switch-disconnectors.

Multi-function logic meets all requirements:

- standard switching logic that allows normal and emergency lines to be monitored, commands to be transmitted to the generator and verification that the circuit-breakers have been switched (ATS021, ATS022);
- control of the two lines, both of which are non-priority (ATS021, ATS022);
- control of a third, bus-tie breaker (ATS022);
- non-priority load disconnection management (ATS022).

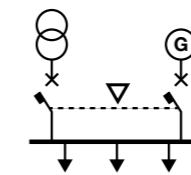

LINE-GENERATOR

If the main network is lost, the ATS021 and ATS022 devices switch to the emergency line equipped with a GenSet.

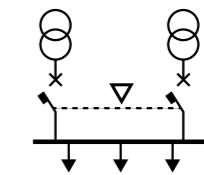

LINE-LINE

If the main network is lost, the ATS021 and ATS022 devices switch to a second line used as a standby. Selection of the priority line from the two available lines is allowed by ATS022.

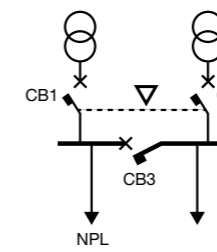

NON-PRIORITY LOAD CONTROL USING A BUS-TIE

If the main network is lost, the ATS022 device switches to a second line used as a standby by disconnecting non-priority loads (NPL) via a bus-tie.

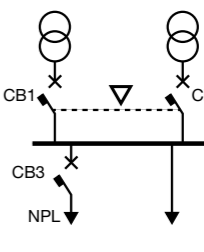

NON-PRIORITY LOAD CONTROL ON THE OUTGOING LINE

If the main network is lost, the ATS022 device switches to a second line used as a standby by disconnecting non-priority loads (NPL) branched from the main busbar.

A single family of moulded-case circuit-breakers up to 3200 A

Motor protection solutions



1

T8 2000A 3 poles with PR332 LSIG
General circuit-breaker used for protecting the load side circuit-breakers dedicated to motor protection.



2

T8 800A 3 poles with PR221-1
Circuit-breaker used for motor protection in conjunction with a thermal relay and a contactor. Instantaneous short-circuit protection (I) can be adjusted from 1 to 10xIn.



3

XT4 250A 3 poles with Ekip M-LRIU
Circuit-breaker used for integrated motor protection. Ekip M-LRIU is fitted with the following protections:

- against overload (L): threshold adjustable from 0.4...1xIn. The tripping time is established by choosing the tripping class defined by standard IEC 60947-4-1.
- rotor locking (R): with threshold adjustable in OFF or from 3...9x I1, with adjustable tripping time;
- against instantaneous short-circuit (I): with threshold adjustable from 6...13xIn and instantaneous tripping time;
- against phase imbalance (U): with threshold adjustable in ON or OFF.



4

XT2 160A 3 poles with MA
Circuit-breaker used for motor protection in conjunction with a thermal relay and a contactor. Instantaneous short-circuit protection (I) can be adjusted from 6...14xIn.



Start-up is a particularly critical phase for the motor itself and for the installation powering it. Even rated service needs to be adequately monitored and protected in order to respond to any faults that might occur.

When it comes to direct starting, ABB SACE proposes two different solutions:

- a conventional system with three poles circuit-breaker equipped with a magnetic only trip unit for protection against short-circuits, a thermal relay for protection against overloads and phase failure or imbalance, and a contactor to operate the motor;
- an advanced protection system which integrates all the protection and monitoring functions, and a contactor for operating the motor, in the circuit-breaker itself.

Circuit-breakers for motor protection

Releases	Frame [A]					
	160	200	400	630	800	1000
MF-MA (Magnetic only trip unit)	Tmax XT2-XT3-XT4					
I (Basic Magnetic only trip unit)	Tmax XT2-XT4-T5-T6-T7-T8					
LIU (Advanced Magnetic only trip unit)	Tmax XT2-XT4					
LRIU (Advanced Magnetic only trip unit)	Tmax XT2 - XT4 - T5 - T6					

3

200A motor start-up unit

Protection and operation are guaranteed by circuit-breaker XT4 Ekip M-LRIU In200A 3p in conjunction with the contactor.



4

20A motor start-up unit

Protection and operation are guaranteed by circuit-breaker XT2 MA In20A 3p in conjunction with the thermal relay and contactor.

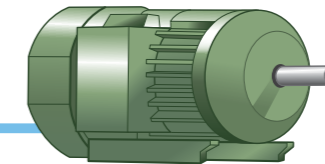

Coordination tables

Suitable devices for protection and motor operation can be identified, given the type of starting, the electrical characteristics of the installation and the characteristics of the motor.

Motor		MCCB		Contactor		Thermal relay		
Rated power	Rated current	Type	Magnetic protection setting	Type	Type	Setting range		I max
Pe	Ie		[A]			min [A]	max [A]	[A]
5.50	11.50	XT2S 160 MF 12.5	175	AF38	EF19-18.9	5.70	18.90	12.50
7.50	15.50	XT2S 160 MA 20	240	AF38	EF19-18.9	5.70	18.90	18.90
9.00	18.60	XT2S 160 MA 20	280	A50	EF45-30	9	30	20
11.00	22.00	XT2S 160 MA 32	320	A50	EF45-30	9	30	30

A single family of moulded-case circuit-breakers up to 3200 A

Certifications and Shipping Registers

The moulded-case circuit-breakers and their accessories comply with IEC60947-2 international standards and conform to EC directive "Low Voltage Directives (LVD) N° 73/23 EEC" and "Electromagnetic Compatibilities Directives (EMC) N° 89/ 336 EEC".



Certification of conformity with the product Standards is carried out in the ABB SACE tests laboratory (accredited by SINAL) in respect of the EN 45011 European Standard, by the Italian certification body ACAE (Association for Certification of Electrical Apparatus), member of the European LOVAG organisation (Low Voltage Agreement Group) and by the Swedish certification body SEMKO belonging to the international IECEE organisation.

The SACE Tmax XT series has a hologram on the front, obtained using special anti-forgery techniques, a guarantee of the quality and genuineness of the circuit-breaker as an ABB SACE product.

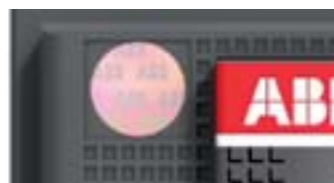

There is also an entire range of moulded-case circuit-breakers conforming to UL/CSA standards, with rated current values ranging from 1 to 3000A and breaking capacities, at 600V AC, that can reach 100kA.

All the equipment also conforms to the specifications for installations on board and to those of RINA, DNV, BV, ABS, GL, LR, PRS, RMRS, NKK type-approvals.



Corporate Quality System

The ABB SACE Quality System conforms with the following Standards:

- ISO 9001 international Standard;
- EN ISO 9001 (equivalent) European Standards;
- UNI EN ISO 9001 (equivalent) Italian Standards;
- IRIS International Railway Industry Standard

The ABB SACE Quality System attained its first certification with the RINA certification body in 1990.

The ABB laboratory

The ABB S.p.A - ABB SACE Division Laboratory develops, certifies and performs follow-up activities for the production of switchgear and controlgear designed and manufactured in various different ABB plants. The Laboratory provides a vast range of installations and experience with regard to the electrical, mechanical, climatic and functional tests required for low and medium voltage operating, control, safety and measuring mechanisms.



The Laboratory has been certified in Italy by ACCREDIA and, due to acknowledgements from important international certification bodies such as ACAE/LOVAG, ANCE, ASTA, ETL, SEMKO, UL, CSA and Shipping Registers, offers ABB and external customers a qualified certification test service for low and medium voltage electrical devices and equipment, in accordance with the respective product standards.

ABB's respect for the environment

Attention to protection of the environment is a priority commitment for ABB SACE. Confirmation of this is the realisation of an Environmental Management System certified by RINA (ABB SACE was the first industry in the electromechanical sector in Italy to obtain this recognition) in conformity with the International ISO14001 Standard.



In 1999 the Environmental Management System was integrated with the Occupational Health and Safety Management System according to the OHSAS 18001 Standard and later, in 2005, with the SA 8000 (Social Accountability 8000) Standard, committing itself to respect of business ethics and working conditions.

The commitment to environmental protection becomes concrete through:

- selection of materials, processes and packaging which optimise the true environmental impact of the product
- use of recyclable materials
- voluntary respect of the RoHS directive

ISO 14001, 18001 and SA8000 recognitions together with ISO 9001 made it possible to obtain RINA BEST FOUR CERTIFICATION.

Contacts

ABB SACE

A division of ABB S.p.A.

L.V. Circuit-breakers

Via Baioni, 35

24123 Bergamo

Tel.: 035 395 111

Fax: 035 395306-433

bol.it.abb.com

www.abb.com

The data and illustrations are not binding.
We reserve the right to modify the contents of this document without prior notice following technical and product developments.

Copyright 2012 ABB. All rights reserved.

1SDC210053B0201 - 05.2012 - 3.000